











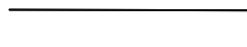

MAPA MUNICIPAL DE AMONTADA

SINUS CONVENCIONAIS

- Área Urbana 
- Revestimento sólido 
- Revestimento solto 
- Caminho, Trilho 
- Limite Municipal 
- Igreja, Escola, Casa 
- Ponto Cotado  x792
- Litoral 
- Curso d'água intermitente 
- Curso d'água Permanente 
- Lagoa Permanente /Lagoa Intermitente 
- Agüdes 
- Curva de Nível 

Localização no Estado

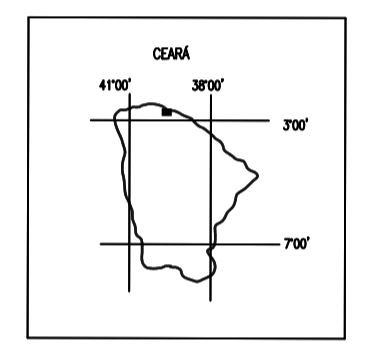

Declinação Magnética

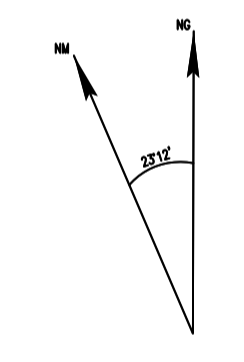

DATUM - SAD69

PROJEÇÃO UNIVERSAL TRANSVERSA DE MERCATOR
 ORIGEM DA QUILOMETRAGEM UTM: "EQUADOR E MERIDIANO 39°W.GR."
 ACRESCIDAS AS CONSTANTES: 10.000 KM E 500 KM,RESPECTIVAMENTE.
 DECLINAÇÃO MAGNÉTICA DO CENTRO DA FOLHA EM 2000:2°12'W.
 CRESCER 2'10" ANUALMENTE.

Mapa com base nas folhas: ITAREMA (558) e ITAIPioca (619), e BELA CRUZ (618) levantadas, desenhadas e impressas pelo DIRETORIA DO SERVIÇO GEOGRÁFICO-BRASIL. Fotografias aéreas de 1968 do SACS. Atualizada pela Divisão de Geografia e Cartografia-IBGE/PLANCE em 1998, utilizando-se de reambulatório em campo e restituição com GPS GARMIN 45 PATHFINDER BASIC PLUS II.

ESCALA GRÁFICA

